

WALLBASE

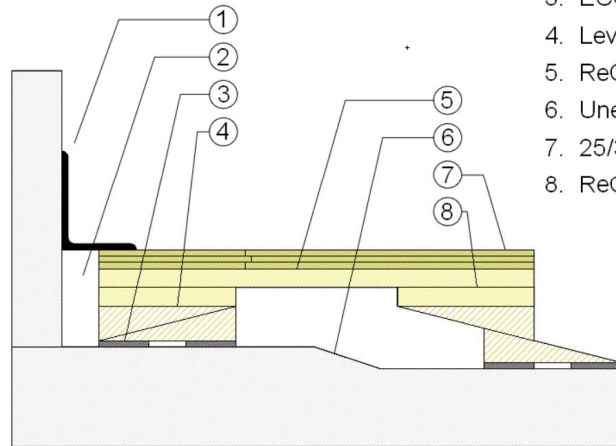

1. 3" x 4" (76mm x 101mm) Vent Cove Base
2. 1-1/2" (38mm) min. Expansion Space
3. ECO Resilient Pad
4. Leveling Wedges at Minimum Profile
5. ReClaim III Subfloor
6. Uneven Concrete Substrate
7. 25/32" (20mm) MFMA Maple Flooring
8. ReClaim III Sleeper

Adjustable
3-7/8" to 4-3/4"
(98mm to 121mm)

Description: RECLAIM III

Resilience: 1/4" (6mm) ECO pads

Drawn By: RR

Date: 1/1/23

Revisions

ID	Description	By	Date

THRESHOLD

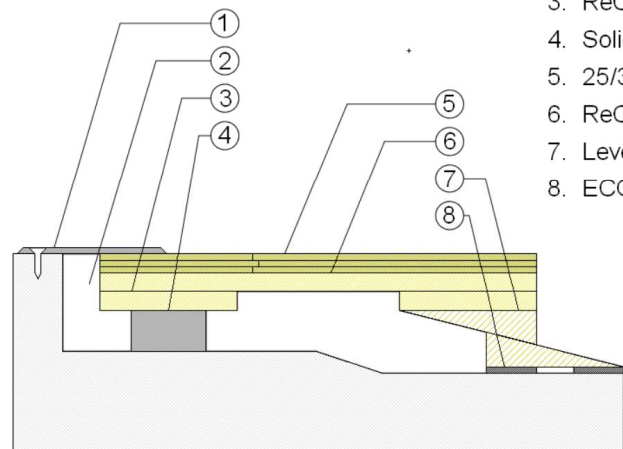

1. 1/4" (6mm) Aluminum Threshold
2. 1-1/2" (38mm) min. Expansion Space
3. ReClaim III Sleeper
4. Solid Blocking at Doorway
5. 25/32" (20mm) MFMA Maple Flooring
6. ReClaim III Subfloor
7. Leveling Wedges at Maximum Profile
8. ECO Resilient Pad

Adjustable
3-7/8" to 4-3/4"
(98mm to 121mm)

EQUIPMENT

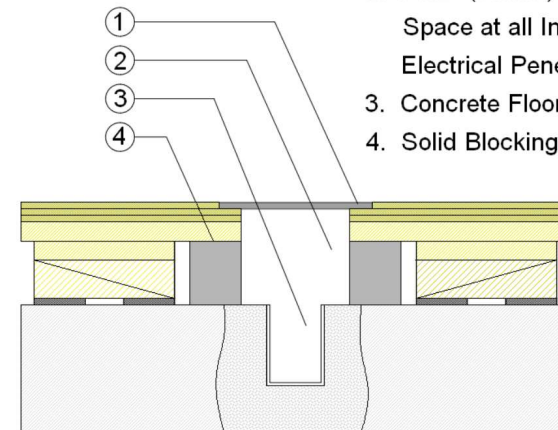

1. Floor Plate
2. 1-1/2" (38mm) Expansion Space at all Inserts and Electrical Penetrations
3. Concrete Floor Penetration
4. Solid Blocking at Insert